

Smart solutions for global window systems.



COMFORT 104

CREMONESI COMFORT RIDOTTA



Cremonesi | Cremone bolts | Cremones | Cremonas



Cassa e manico in alluminio pressofuso; cremagliere, pignone e copricassa in zama zincata; guida e rondella di frizionamento in delrin; viti in acciaio zincato; viti di bloccaggio della cremonese su profilo in acciaio inox.



Case and handle in die-cast aluminum; rack, pinion and cover in galvanized zamak; Delrin guide and friction washer; galvanized steel screws; screws for locking cremone bolts on profile in stainless steel.



Caisse et poignée en aluminium moulé sous pression; crémaillères, pignon et couvre-caisse en zamak ingué; guide et rondelle de friction en delrin; vis en acier zingué; vis de blocage de la cremone sur profile en acier inox.



Caja y mango de aluminio fundido a presión; cremalleras, piñón y cobertura de caja de zamak galvanizado; guía y arandela de fricción de delrin; tornillos de acero galvanizado; tornillos de bloqueo de la cremona sobre perfil de acero inox.









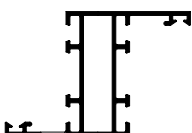
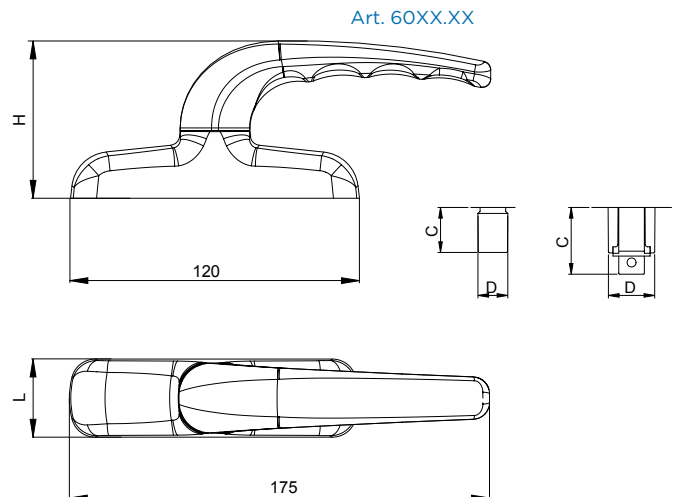
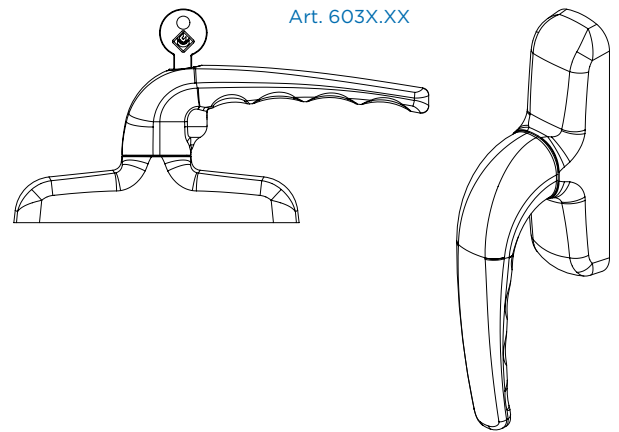
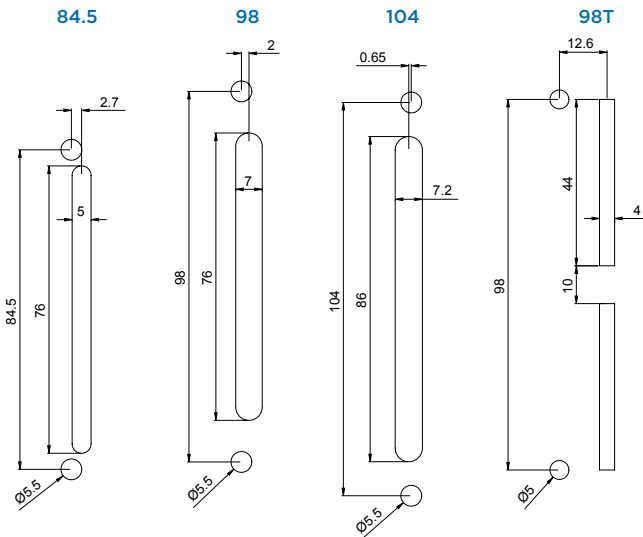



ART.	6005 6005.2 6035				6015 6015.21 6036 6015.41				6036.20D 6036.20S 6036.25D 6036.25S 6036.23D 6036.25S			
Imballo Package Conditionnement Embalaje	20 5 Pz				5 Pz				5 Pz			
Finiture disponibili Available finishes Finitions disponibles Acabados disponibles	1	2	3	4	1	2	3	4	1	2	3	4

* Le confezioni delle cremonesi e delle martelline sono da 20 pezzi, ad esclusione delle versioni in finiture speciali e vintage "OLD" che sono da 5 pezzi.
* Cremone bolts and handles come in packages of 20, except for versions in special and "OLD" vintage finishes that are in packages of 5.

LAVORAZIONI MACHINING



DESCRIZIONE DESCRIPTION	ART.	TIPO DI CURSORE TYPE OF SLIDER	L	H	C	D	CORSA STROKE	LAVORAZIONE MACHINING
"COMFORT 104" Cremonese con interasse 84,5 - 104 mm "COMFORT 104" Cremonese bolt with inter-axe 84,5 - 104 mm	6005		32.5	65.5	21	14	17	84.5 - 104
"COMFORT 104" Cremonese per serie scorrevole Triall.co "COMFORT 104" Cremonese bolt for sliding series Triall.co	6005.2		32.5	65.5	21	14	17	98
 "COMFORT 104" Cremonese per anta ribalta con anti falsa manovra sulla cremonese, interasse 84,5 - 104 mm "COMFORT 104" Cremonese bolt for Tilt and Turn with anti-false manoeuvre on the cremonese bolt, inter-axe 84,5 - 104mm	6015		32.5	65.5	31	22	17 + 17	104
 "COMFORT 104" Cremonese COMFORT 104 per anta ribalta con anti falsa manovra superiore, con interasse 84,5 - 104 mm "COMFORT 104" Cremonese bolt with upper anti-false manoeuvre, inter-axe 84,5 - 104mm	6015.21		32.5	65.5	21	22	17 + 17	84.5 - 104
 COMFORT 104" Cremonese COMFORT 104 con anti falsa manovra superiore, con interasse 84,5 - 104 mm, per scorrevole parallelo SPI60 "COMFORT 104" Cremonese bolt with upper anti-false manoeuvre, inter-axe 84,5 - 104mm, for tilt and slide SPI60.	6015.41		32.5	65.5	21	22	17 + 17	84.5 - 104
"COMFORT 104" Cremonese COMFORT 104 con cilindro, interasse 84,5 - 104 "COMFORT 104" Cremonese bolt with key, inter-axe 84,5 - 104	6035		32.5	65.5	21	14	17	84.5 - 104
 "COMFORT 104" Cremonese con cilindro, per anta ribalta con anti falsa manovra sulla cremonese "COMFORT 104" Cremonese bolt with key, for Tilt and Turn with anti-false manoeuvre on the cremonese bolt	6036		32.5	65.5	31	22	17 + 17	104
 "COMFORT LOGICA" Cremonese con cilindro, per anta ribalta logica con anti falsa manovra sulla cremonese - DX "COMFORT LOGICA" Cremonese bolt with key, for Tilt before Turn with anti-false manoeuvre on the cremonese bolt - RX	6036.20D		32.5	65.5	31	22	17 + 17	104
 "COMFORT LOGICA" Cremonese con cilindro, per anta ribalta logica con anti falsa manovra sulla cremonese - DX "COMFORT LOGICA" Cremonese bolt with key, for Tilt before Turn with anti-false manoeuvre on the cremonese bolt - RX	6036.20S		32.5	65.5	31	22	17 + 17	104
 "COMFORT LOGICA" Cremonese con cilindro, per anta ribalta logica con anti falsa manovra superiore - DX "COMFORT LOGICA" Cremonese bolt with key, for Tilt before Turn with upper anti-false manoeuvre - RX	6036.25D		32.5	65.5	21	22	17 + 17	104
 "COMFORT LOGICA" Cremonese con cilindro, per anta ribalta logica con anti falsa manovra superiore - SX "COMFORT LOGICA" Cremonese bolt with key, for Tilt before Turn with upper anti-false manoeuvre - LX	6036.25S		32.5	65.5	21	22	17 + 17	104
 "COMFORT LOGICA" Cremonese con cilindro, per anta ribalta logica con anti falsa manovra sulla cremonese - DX "COMFORT LOGICA" Cremonese bolt with key, for Tilt before Turn with anti-false manoeuvre on the cremonese bolt - RX	6036.23D		32.5	65.5	31	22	17 + 17	98
 "COMFORT LOGICA" Cremonese con cilindro, per anta ribalta logica con anti falsa manovra sulla cremonese - DX "COMFORT LOGICA" Cremonese bolt with key, for Tilt before Turn with anti-false manoeuvre on the cremonese bolt - RX	6036.23S		32.5	65.5	31	22	17 + 17	98



SCANSIONA IL QR CODE E GUARDA
IL NOSTRO CANALE YOUTUBE
*SCAN QR CODE AND FIND OUT
MASTER TUBE CHANNEL.*



Master Italy S.r.l.
S.P. 37 Conversano - Castiglione km 0,570 - Conversano (BA) Italy
Customer Service +39 080 4959823 -Fax. +39 080 4959030
info@masteritaly.com

MASTER implements its environmental policy by FSC Certification and by using low environmental impact inks.
This product has been printed under chain of custody (COC) and using only vegetable based inks.

